

TAN75A

75 Watts, 50 Volts, Pulsed
Avionics 960 - 1215 MHz

GENERAL DESCRIPTION

The TAN75A is a high power COMMON BASE bipolar transistor. It is designed for pulsed systems in the frequency band 960-1215 MHz. The device has gold thin-film metallization and diffused ballasting for proven highest MTTF. The transistor includes input and output prematch for broadband capability. Low thermal resistance package reduces junction temperature, extends life.

CASE OUTLINE 55AZ, STYLE 1

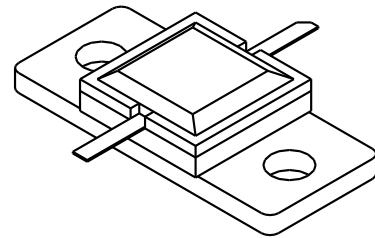

ABSOLUTE MAXIMUM RATINGS

Maximum Power Dissipation @ 25°C² 290 Watts

Maximum Voltage and Current

BVces Collector to Base Voltage 55 Volts
BVebo Emitter to Base Voltage 4 Volts
Ic Collector Current 9 Amps

Maximum Temperatures

Storage Temperature - 65 to + 200°C
Operating Junction Temperature + 200°C

ELECTRICAL CHARACTERISTICS @ 25 °C

SYMBOL	CHARACTERISTICS	TEST CONDITIONS	MIN	TYP	MAX	UNITS
P _{out}	Power Out	F = 960-1215 MHz	75	80		Watts
P _{in}	Power Input	V _{cc} = 50 Volts			12	Watts
P _g	Power Gain	PW = 20 μsec	8.0	8.5		dB
η _c	Collector Efficiency	DF = 5%		40		%
V _{SWR}	Load Mismatch Tolerance	F = 1090 MHz			20:1	

BVebo	Emitter to Base Breakdown	I _e = 10 mA	4			Volts
BVces	Collector to Emitter Breakdown	I _c = 15 mA	50			Volts
h _{FE}	DC - Current Gain	I _c = 15 mA, V _{ce} = 5 V	10		100	
θ _{jc} ²	Thermal Resistance				0.6	°C/W

Note 1: A rated output power and pulse conditions

2: At rated pulse conditions

Initial Issue June, 1994

GHz TECHNOLOGY INC. RESERVES THE RIGHT TO MAKE CHANGES WITHOUT FURTHER NOTICE. GHz RECOMMENDS THAT BEFORE THE PRODUCT(S) DESCRIBED HEREIN ARE WRITTEN INTO SPECIFICATIONS, OR USED IN CRITICAL APPLICATIONS, THAT THE PERFORMANCE CHARACTERISTICS BE VERIFIED BY CONTACTING THE FACTORY.

POWER OUTPUT vs POWER INPUT

Vcc = 50 V, 1090 MHz

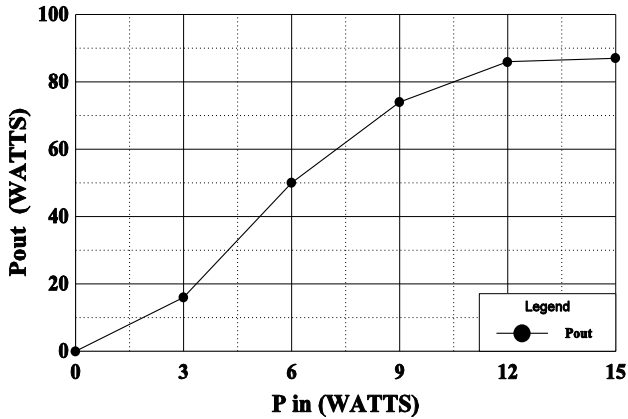

POWER OUTPUT vs FREQUENCY

Vcc = 50 V, F = 1090 MHz

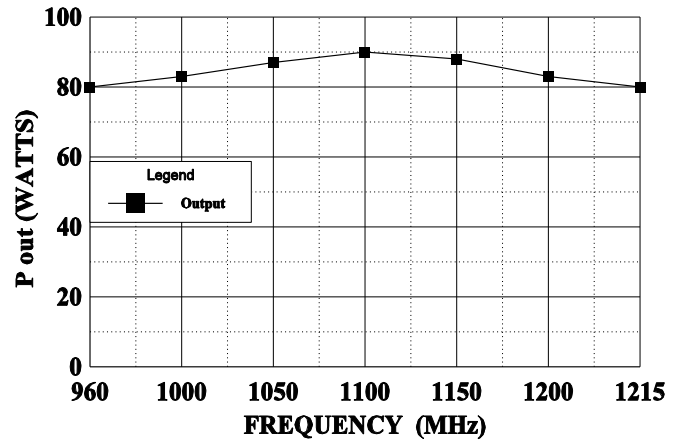

SERIES INPUT IMPEDANCE vs FREQUENCY

Vcc = 50 V, Pout = 75 W

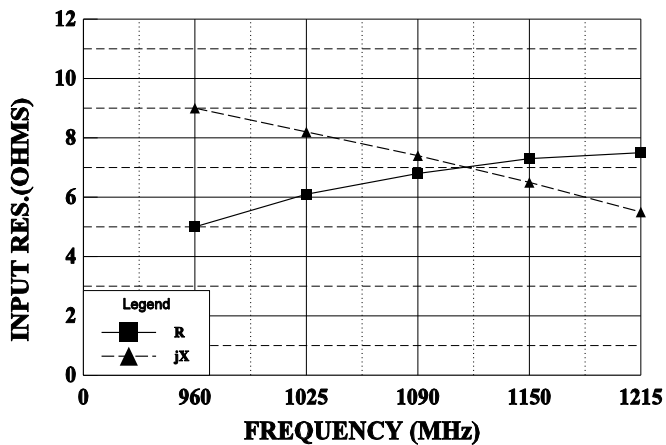

SERIES LOAD IMPEDANCE vs FREQUENCY

Vcc = 50 V, Po = 75 W

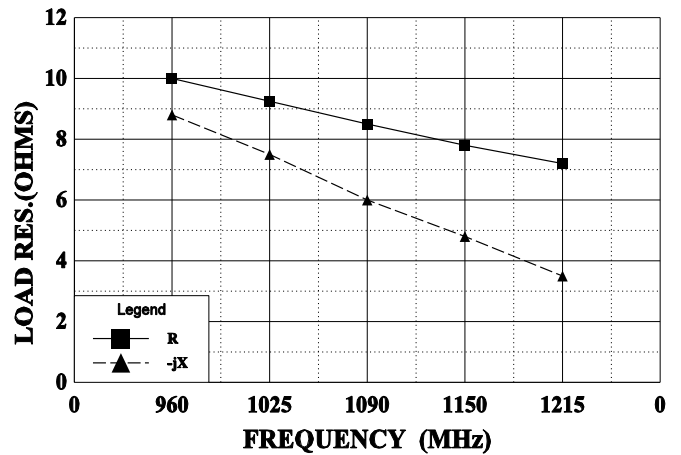

REVISIONS

ZONE	REV	DESCRIPTION	DATE	APPROVED
------	-----	-------------	------	----------

DIM	INCHES
A	.050
B	.050
C	.200
D	.225
E	.400
F	.025
G	.110
H	.200
I	.025
J	.050
K	.050
L	.260
M	.200
N	.360
O	.025

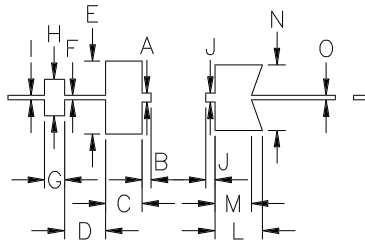

TAN75A TEST CIRCUIT

f = 960-1215MHz
Vcc = 50V
10μsec @ 5% duty

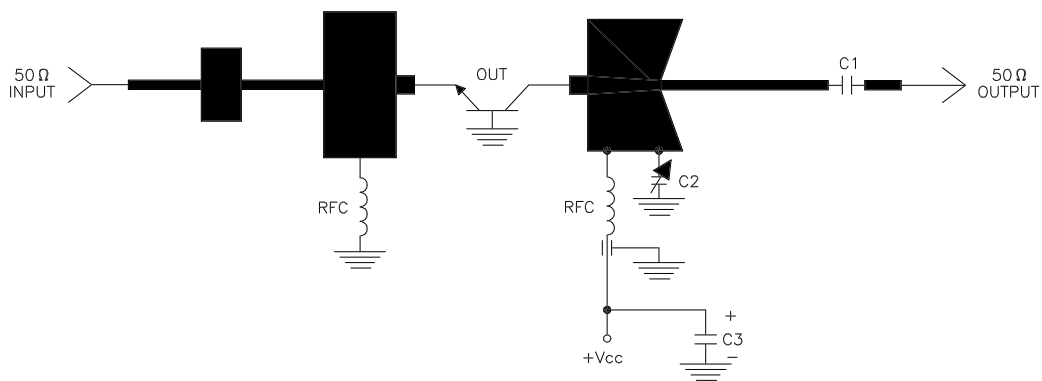

— = Microstrip on 25 mil alumina; Er=10
C1 = 82pF chip cap
C2 = 0.3 - 3.5pF variable
C3 = 100 MFD @ 50V



CAGE OPJR2	DWG NO. TAN 75A	REV A
	SCALE 1/1	SHEET